

See discussions, stats, and author profiles for this publication at: <https://www.researchgate.net/publication/290311901>

# Beam simulation of SQQ injection system in KIRAMS-30 cyclotron

Article · January 2006

CITATIONS

6

READS

206

13 authors, including:



**Dong Hyun An**

Korea Institute of Radiological & Medical Sciences

53 PUBLICATIONS 250 CITATIONS

[SEE PROFILE](#)



**Joonsun Kang**

Institute for Basic Science

43 PUBLICATIONS 185 CITATIONS

[SEE PROFILE](#)



**In Su Jung**

Korea Institute of Radiological & Medical Sciences

34 PUBLICATIONS 124 CITATIONS

[SEE PROFILE](#)



**Bong hwan Hong**

Korea Institute of Radiological & Medical Sciences

54 PUBLICATIONS 190 CITATIONS

[SEE PROFILE](#)

# BEAM SIMULATION OF SQQ INJECTION SYSTEM IN KIRAMS-30 CYCLOTRON \*

Dong Hyun An, Joonsun Kang, In Su Jung, Hong Suk Jang, Bong Hwan Hong,  
Min Goo Hur, Seong Seok Hong, Won Taek Hwang, Jeong Hwan Kim, Min Yong Lee,  
Tae Keun Yang, Yoo-Seok Kim, Jong-Seo Chai, KIRAMS, Seoul, Korea

## Abstract

The injection system of KIRAMS-30 cyclotron consists of a double gap buncher, an SQQ, and a spiral inflector. Initial beam with 100 mmmrad has been generated by random Gaussian function in the transverse plane and random uniform function in the longitudinal direction. Using the 3D electric and magnetic fields of a buncher, SQQ, inflector, and return-yoke bore, the characteristics of the beam injected into the KIRAMS-30 cyclotron's central region has been obtained. This paper presents the results of its beam characteristics and parameters of each beam element.

## INTRODUCTION

KIRAMS-30 cyclotron have been manufacturing for installation at KAERI and will be commissioned next year. The injection system of KIRAMS-30 cyclotron has a double gap buncher, SQQ system, a spiral inflector, and return yoke magnetic field. This paper devotes to calculate the beam properties through the injection system with the background magnetic field in the injection hole by the main magnet of cyclotron. The magnetic field and electric field of SQQ and Inflector are calculated from TOSCA, and the electric field distribution of the buncher is obtained by POISSON.

## INJECTION SYSTEM

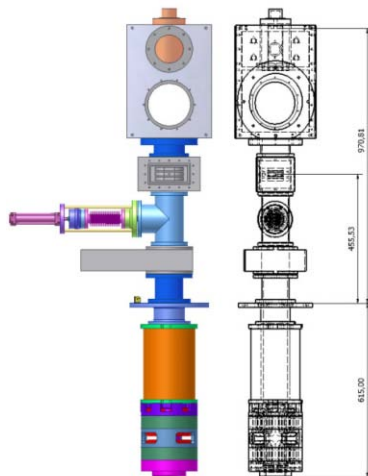

Figure 1: KIRAMS-30 Injection System

\* Work supported by the Mid- and Long-term Nuclear R&D program of Ministry of Science & Technology, South Korea

The KIRAMS-30 cyclotron has a TRIUMF style DC multicusp ion source[1]. The unnormalized emittance containing 90% beam intensity is about 100 mmmrad at high current. It means that Gaussian beam has rms beam waist radius of about 3 mm and rms divergence of about 20 mrad.

First the beam envelope behaviour in the drift space of 1.7 m long has been simulated. The beam current is assumed as 10 mA, and space charge neutralization factor 0.9[2]. The space charge effect is calculated only in the transverse direction. The distance from the median plane to the top yoke is 0.72 m, and the distance from the beam waist of ion source to the top yoke is 0.95 m. From the drift simulation, the rms beam size at 1.1 m downstream is about 23 mm with the space charge effect. The solenoid bore radius is determined as 45 mm.

The particle's trajectory tracking is achieved by Mathematica Notebook which contains the beam generation and information, the integrations of equations of motion, and the calculation of space charge interactions.

## Buncher

The nominal buncher can be normally used in the low current range. The observed limit of the bunching gain factor is 2.15 due to the space charge effect and the transit time effect, but theoretical limitation is 3.5 with a sinusoidal buncher[3]. The double gap buncher of KIRAMS-30 cyclotron uses the same cyclotron resonance frequency 63.95 MHz and an additional phase shifter to match between acceleration and beam bunch's time sequence at acceleration gaps in the cyclotron.

Figure 2 shows electric potential map and bunching effects at 1.2 m downstream from the buncher. The electric potential map of the buncher is generated by SUPERFISH, POISSON. The buncher is composed of two RF gaps and one center excitation body. The gap size is 4 mm. The distance between gap centers is 18.7 mm and the aperture radius is 30 mm. In order to avoid field penetration into another gap and drift region and transit time variation in the radial direction, the wires are used. The buncher voltage is 200 V. The bunch has 77 deg RF phase width with corresponding to 90% of a bunch peak and the suppression factor 2.4.

## SQQ

There are several types of an injection line from an ion source to an inflector in the compact cyclotrons[4, 5]. The KIRAMS-30 cyclotron has a SQQ injectin system in a ver-

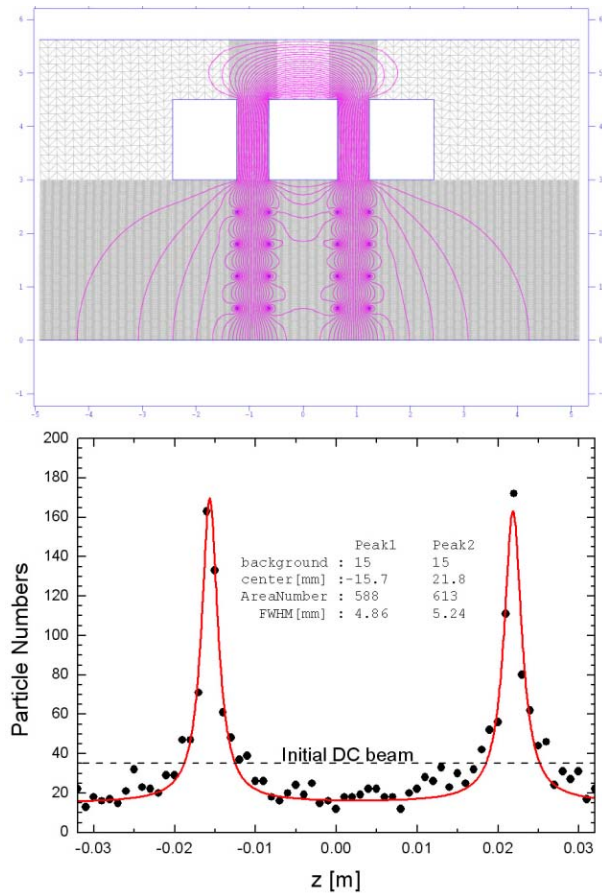

Figure 2: The electric potential map of the buncher, the position  $z$  [m] vs. the particle number. The buncher voltage is about 200 V.

tical yoke hole. Figure 3(a) shows the SQQ drawing and sizes. The solenoid bore size is determined from the drift simulation as 90 mm. This size is not enough when initial beam 4rms emittance is larger than 100 mmmrad. Figure 3(b) shows the axial magnetic field distribution with  $z$  (0.0 at cyclotron's median plane). The 3 dimensional magnetic field maps of SQQ and Yoke have been obtained with TOSCA in OPERA3D. The bore size of the vertical yoke hole is 200 mm to install the SQQ device.

With the 3D magnetic field of yoke hole and SQQ, beam simulation have been carried out. Figures 4 and 5 show the results of the simulation.

### Spiral Inflector

In order to bend the beam from axial direction onto cyclotron median plane, a spiral inflector is used. First the shape of inflector is obtained by CASINO[6] and INFLECTOR[7] program with various  $k'$ , electric field radius  $A$ , and inflector height using 3D magnetic field distribution.

First  $z = 0$  condition at the inflector exit is used to determine the  $A$  and inflector height. With the variation of the angle between cyclotron Hill configuration and the inflec-

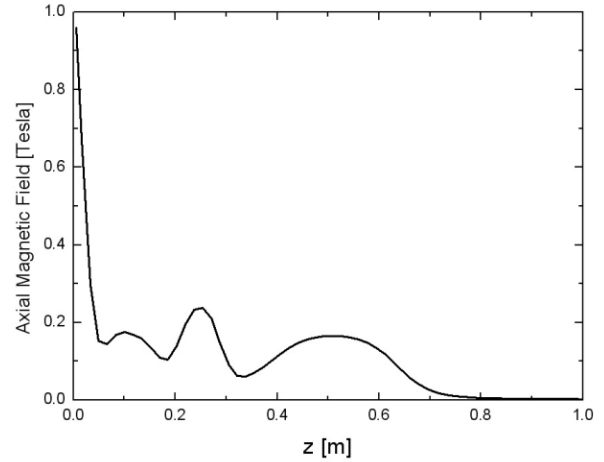
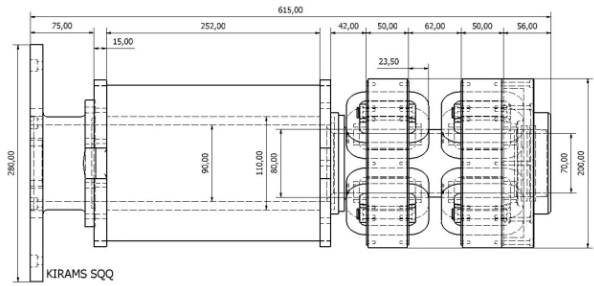

Figure 3: (a) SQQ drawing (b) axial magnetic field variation with  $z$

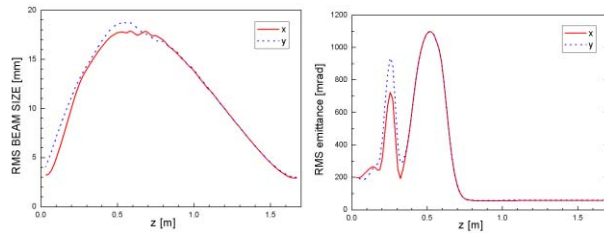

Figure 4: (a) Beam envelope behaviour from the initial beam waist position to the entrance of the spiral inflector. (b) RMS emittance variation with respect to  $z$  in the transverse plane.

tor electrode, the beam position and direction at the exit of inflector have been adjusted. But the results have some limitation of the beam direction at some beam position. The more variation can be achieved with  $k'$  values for beam centering of several turns in the central region, but in the view of the dependence of acceptance on tilt for an inflector with the aspect ratio of 2, the correlated acceptance falls to 50% of the untilted value at  $k' = -1.0$ [8].

The spiral inflector of KIRAMS-30 cyclotron has  $A = 2$  cm, inflector height 1.88 cm,  $k' = 0$ , electrode gap 8 mm, and aspect ratio 2. Figure 6 shows the shape of the spiral inflector and the representative potential map. This calculation is carried out with OPERA3D, TOSCA with a 3D CAD drawing SAT file.

Figure 7 shows initial and final beam information of spi-

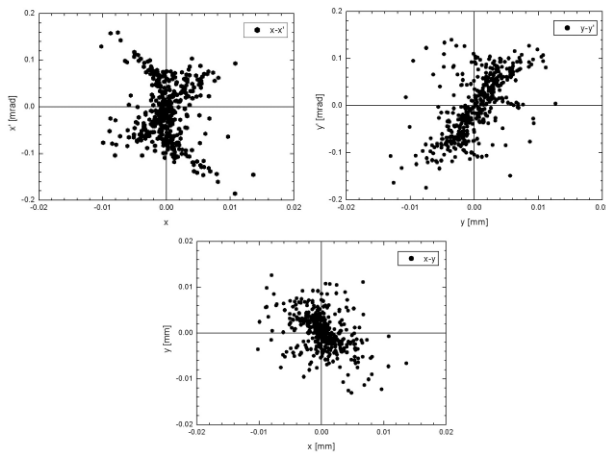

Figure 5: Beam distribution in trace space and  $x$ - $y$  transverse plane at the entrance of the spiral inflector.

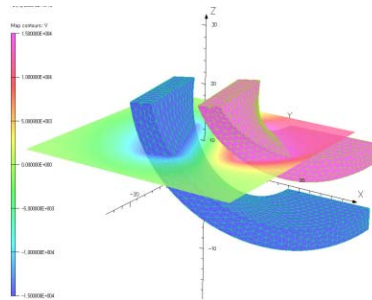

Figure 6: Spiral Inflector and the representative potential map

ral inflector. The initial beam size is about 4 mm. The final beam is spreading in radial direction and focusing in vertical direction. At the next tracking the beam is focused in the radial direction by bending effect due to the cyclotron's magnetic field and spread in the vertical direction. For this simulation to get  $z = 0$  condition at the exit of spiral inflector, electrode's voltage should be reduced by the factor of 0.75 compared to CASINO result. The inflector voltage is about  $\pm 11.3$  kV at the upper and lower electrode.

### CONCLUSIONS

The injection system of KIRAMS-30 have been developed to accept 100 mmmrad 4rms emittance beam generated from an ion source. It is composed of a double gap buncher, SQQ system, and a spiral inflector. A double gap buncher has the electrode gap size 4 mm and 200 V buncher voltage. The bore size of the Solenoid is 90 mm. The electric radius, electrode gap size, and aspect ratio of the spiral inflector is 2 cm, 8 mm, and 2, respectively.

From the results, the injection system without spiral inflector is satisfied to get enough acceptance of the initial beam condition. But the spiral inflector needs more small and fine beam condition for the less beam loss. It needs more studies on QQ condition to make various beam states

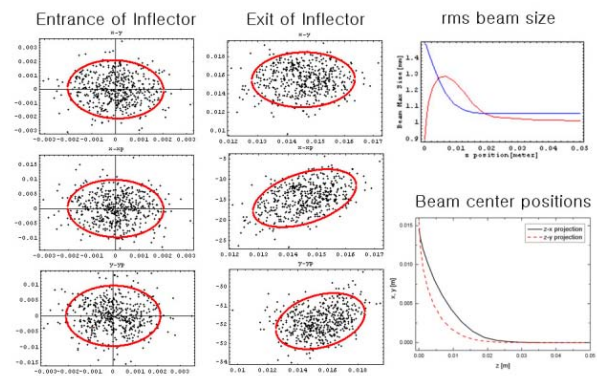

Figure 7: Beam distribution at the entrance and exit of Spiral Inflector, RMS beam size, and variation of the beam center position through the spiral inflector.

at the entrance of spiral inflector for the beam matching between injection line and spiral inflector.

### REFERENCES

- [1] M. P. Dehnel, T. Stewart, M. Roeder, K. Le Du, "An ion source upgrade for an axial injection based commercial cyclotron", NIM B, **241** (2005) 896.
- [2] R. Baartman, "Space Charge Neutralization Studies of an H-Beam", EPAC (1988) 949.
- [3] R. Baartman, "Intensity limitations in Compact H-minus Cyclotrons", 14th International conference on cyclotrons and their Applications, Capetown, 1995, 440.
- [4] T. Kuo, R. Baartman et al., "A Comparison of Two Injection Line Matching Sections for Compact Cyclotrons", PAC, Dallas, 1995.
- [5] M. Dehnel and T. Stewart, "An Industrial cyclotron ion source & injection system", CYC, 2004
- [6] B. F. Milton and J. B. Pearson, TRIUMF design note TRI-DN-89-19, 1989.
- [7] L. Milinkovic, TRIUMF design note TRI-DN-89-21, 1989.
- [8] R. J. Balden, W. Kleeven, et al., "Aspects of phase space dynamics in spiral inflectors", 12th Int. Conf. on Cyclotrons and their Application, Berlin, 1989.